

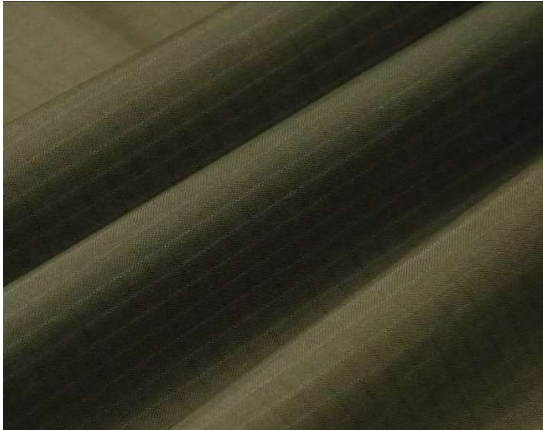

MATERIAL SALES

1. CLOTH PARACHUTE NYLON-MAIN CANOPY

CODE NO	LBP-01	SAMPLE
PART NO	MIL/PIA-C-44378-T/1	
YARN	30d	
Construction	114 X 132	
Weave	Ripstop	
Widths	36" / 48"	
Weight	1,17	
Thickness	0,003	
Air Perm	0-5	
Tear W/F	5/5	
Break W/F	45/45	
pH	5.5-9.0	
1 SET QUANTITY		

2. BALISTIC CLOTH-MAIL PACK

CODE NO	LBP-02	SAMPLE
PART NO	MIL/PIA-C-3953	
YARN	1050d	
Construction	114 X 132	
Weave	3 * 4 BASKET	
Widths	36"	
Weight	581.18 g/yd2	
Thickness	-	
Air Perm	-	
Tear W/F	-	
Break W/F	1100 LBS(MIN)	
pH	-	
1 SET QUANTITY		

3. CLOTH COTTON SATEEN-DEPLOYMENT BAG

code no	LBP-03	SAMPLE
PART NO	MIL/PIA-C-10296-T/1	
YARN	COTTON YARN	
Construction	114 X 132	
Weave	5/5 SATEEN	
Widths	60"	
Weight	249.58 g/yd2	
Thickness	-	
Air Perm	-	
Tear W/F	-	
Break W/F	115/100 LBS(MIN)	
pH	-	
1 SET QUANTITY		

4. CLOTH DUCK NYLON-MAIN PACK & CARRYING BAG

CODE NO	LBP-04	SAMPLE
PART NO	MIL/PIA-C-7219-T/3	
YARN	420 D	
Construction	114 X 132	
Weave	PLAIN	
Widths	60"	
Weight	205.54 g/yd ²	
Thickness	0,003	
Air Perm	0-5	
Tear W/F	5/5	
Break W/F	325 * 275	
colour	G	
1 SET QUANTITY		

5. COTTON DUCK-STATIC LINE COVER

CODE NO	LBP-05	SAMPLE
PART NO	MIL/PIA-C-419-T/3	
YARN	COTTON	
Construction		
Weave	PLAIN	
Widths	60"	
Weight	7.75 oz/liner yd(max)	
Thickness		
Air Perm	-	
Tear W/F	-	
Break W/F	-	
pH	-	
1 SET QUANTITY		

6. CLOTH, PARACHUTE, NYLON-RIPSTOP AND TWILL WEAVE

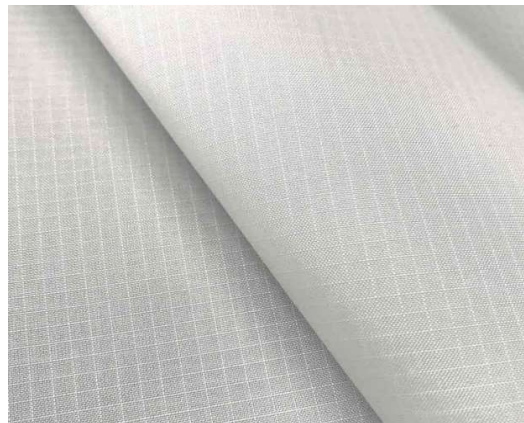
CODE NO	LBP-06	SAMPLE
PART NO	MIL/PIA-C-7020-T/1	
YARN	30d	
Construction	120 X 120	
Weave	Ripstop	
Widths	36" / 48"	
Weight	1,1	
Thickness	0,003	
Air Perm	100 +/-20	
Tear W/F	5	
Break W/F	42	
pH	5.5-9.0	
1 SET QUANTITY		



7. WEBBING,TEXTILE,WOVEN NYLON

CODE NO	LBP-07	SAMPLE
PART NO	MIL-W-4088-T/1	
WIDTHS	9/16"	
WEIGHTS	0.20 oz/liner yd(max)	
BREAKING STRENGTH	500 lbs	
MATERIAL	NYLON	
COLOR	NW & OG	
1 SET QUANTITY		
REMARK	RADIAL-SEAM , V-TAPE	

8. WEBBING,TEXTILE,WOVEN NYLON

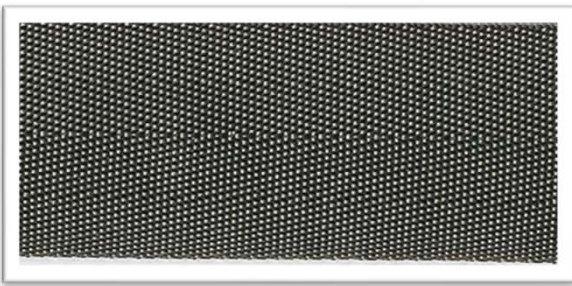
CODE NO	LBP-08	SAMPLE
PART NO	MIL-W-4088-T-2	
WIDTHS	1"	
WEIGHTS	0.32 oz/liner yd(max)	
BREAKING STRENGTH	600 lbs	
MATERIAL	NYLON	
COLOR	OG	
1 SET QUANTITY		
REMARK	RESERVE PACK TRAY	

9. WEBBING,TEXTILE,WOVEN NYLON

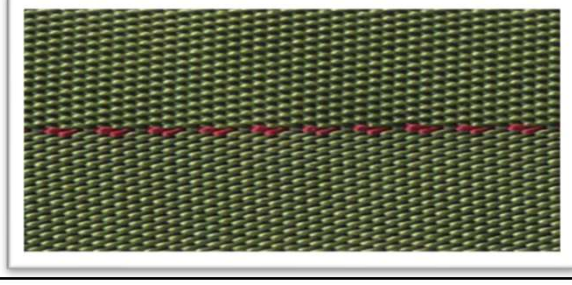
CODE NO	LBP-09	SAMPLE
PART NO	MIL-W-4088-T-6	
WIDTHS	1 23/32"	
WEIGHTS	1.15 oz/liner yd(max)	
BREAKING STRENGTH	2500 lbs	
MATERIAL	NYLON	
COLOR	OG	
1 SET QUANTITY		
REMARK	PACK TRAY	

10. WEBBING,TEXTILE,WOVEN NYLON

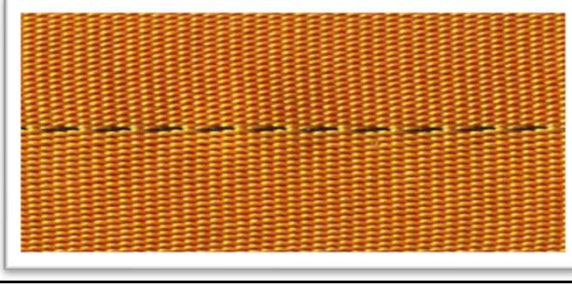
CODE NO	LBP-10	SAMPLE
PART NO	MIL-W-4088-T-8	
WIDTHS	1 23/32"	
WEIGHTS	1.60 oz/liner yd(max)	
BREAKING STRENGTH	4000 lbs	
MATERIAL	NYLON	
COLOR	YL	
1 SET QUANTITY		
REMARK	STATIK LINE / DEPLOYMENT BAG	



11. WEBBING,TEXTILE,WOVEN NYLON

CODE NO		SAMPLE
PART NO	MIL-W-4088-T/12	
WIDTHS	1 23/32"	
WEIGHTS	0.85 oz/liner yd(max)	
BREAKING STRENGTH	1200 lbs	
MATERIAL	NYLON	
COLOR	OG	
1 SET QUANTITY		
REMARK	RISER/HARNESS/PACK TRAY/DEPLOYMENT BAG	

12. WEBBING,TEXTILE,WOVEN NYLON

CODE NO	LBP-12	SAMPLE
PART NO	MIL-W-4088-T/13	
WIDTHS	1 23/32"	
WEIGHTS	2.90 oz/liner yd(max)	
BREAKING STRENGTH	7000 lbs	
MATERIAL	NYLON	
COLOR	OG	
1 SET QUANTITY		
REMARK	HARNESS & RISER	

13. WEBBING,TEXTILE,WOVEN NYLON

CODE NO	LBP-13	SAMPLE
PART NO	MIL-W-4088-T-17	
WIDTHS	1"	
WEIGHTS	1.15 oz/liner yd(max)	
BREAKING STRENGTH	2500 lbs	
MATERIAL	NYLON	
COLOR	OG	
1 SET QUANTITY		
REMARK	PACK TRAY	

14. WEBBING,TEXTILE,NYLON,TUBULAR

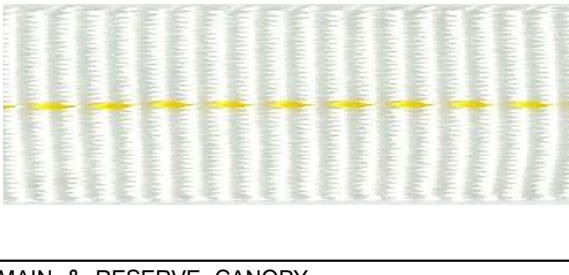
CODE NO	LBP-14	SAMPLE
PART NO	MIL-W-5625-1"	
WIDTHS	1"	
WEIGHTS	1.70 oz/liner yd(max)	
BREAKING STRENGTH	4000 lbs	
MATERIAL	NYLON	
COLOR	NW	
1 SET QUANTITY		
REMARK	MAIN & RESERVE CANOPY	



15. WEBBING,TEXTILE,NYLON,TUBULAR

CODE NO	LBP-15	SAMPLE 
PART NO	MIL-W-5625-1/2"	
WIDTHS	1/2"	
WEIGHTS	0.50 oz/liner yd(max)	
BREAKING STRENGTH	1000 lbs	
MATERIAL	NYLON	
COLOR	OG	
1 SET QUANTITY		
REMARK		

16. TAPE,TEXTILE AND WEBBING,TEXTILE REINFORCING,NYLON

CODE NO	LBP-16	SAMPLE 
PART NO	MIL-T-5038-3-3/8"	
WIDTHS	3/8"	
WEIGHTS	0.12 oz/liner yd(max)	
BREAKING STRENGTH	200 lbs	
MATERIAL	NYLON	
COLOR	OG	
1 SET QUANTITY		
REMARK	RESERVE PACK TRAY	

17. TAPE,TEXTILE AND WEBBING,TEXTILE REINFORCING,NYLON

CODE NO	LBP-17	SAMPLE 
PART NO	MIL-T-5038-3-3/4"	
WIDTHS	3/4"	
WEIGHTS	0.20 oz/liner yd(max)	
BREAKING STRENGTH	400 lbs	
MATERIAL	NYLON	
COLOR	OG	
1 SET QUANTITY		
REMARK	CANOPY / RISER / HARNESS / PACK TRAY	

18. TAPE,TEXTILE AND WEBBING,TEXTILE REINFORCING,NYLON

CODE NO	LBP-18	SAMPLE 
PART NO	MIL-T-5038-1.5"	
WIDTHS	1.5"	
WEIGHTS	0.40 oz/liner yd(max)	
BREAKING STRENGTH	850 lbs	
MATERIAL	NYLON	
COLOR	OG	
1 SET QUANTITY	1.40 M	
REMARK	RISER & HARNNES	



19. TAPE,TEXTILE AND WEBBING,TEXTILE REINFORCING,NYLON

CODE NO	LBP-19	SAMPLE 
PART NO	MIL-W-5038-4-1"	
WIDTHS	1"	
WEIGHTS	0.50 oz/liner yd(max)	
BREAKING STRENGTH	1000 lbs	
MATERIAL	NYLON	
COLOR	OG	
1 SET QUANTITY		
REMARK	CARRYING BAG	

20. TAPE,TEXTILE AND WEBBING,TEXTILE REINFORCING,NYLON

CODE NO	LBP-20	SAMPLE 
PART NO	MIL-T-5038-4-1.5"	
WIDTHS	1.5"	
WEIGHTS	0.75 oz/liner yd(max)	
BREAKING STRENGTH	1500 lbs	
MATERIAL	NYLON	
COLOR	OG	
1 SET QUANTITY		
REMARK	PILOTCHUTE	

21. TAPE, TEXTILE, NYLON, PARACHUTE CONSTRUCTION

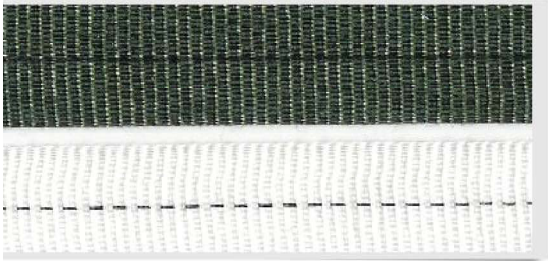
CODE NO	LBP-21	SAMPLE 
PART NO	MIL-T-6134-1"	
WIDTHS	1"	
WEIGHTS	0.40 oz/liner yd(max)	
BREAKING STRENGTH	500 lbs	
MATERIAL	-	
COLOR	WHITE & OG	
1 SET QUANTITY	W,55.00/OG 8.60 M	
REMARK	MAIN & RESERVE CANOPY	

22. TAPE AND WEBBING, TEXTILE,WOVEN REINFORCING, COTTON

CODE NO	LBP-22	SAMPLE 
PART NO	MIL-T-5661	
WIDTHS	3/4"	
WEIGHTS	0.14 oz/liner yd(max)	
BREAKING STRENGTH	75 lbs	
MATERIAL	COTTON	
COLOR		
1 SET QUANTITY		
REMARK	DEPLOYMENT BAG	



23. Webbing,Textile, Cotton, General Purpose

CODE NO	LBP-23	SAMPLE
PART NO	MIL-W-530-2-3"	
WIDTHS	3"	
WEIGHTS	2.13 oz/liner yd(max)	
BREAKING STRENGTH	810 lbs	
MATERIAL	COTTON	
COLOR	OG	
1 SET QUANTITY		
REMARK	DEPLOMENT BAG & RESERVE PACK TRAY	

24. WEBBING,TEXTILE COTTON WARP

CODE NO	LBP-24	SAMPLE
PART NO	MIL-W-5665-2-1"	
WIDTHS	1"	
WEIGHTS	0.75 oz/liner yd(max)	
BREAKING STRENGTH	575 lbs	
MATERIAL	COTTON	
COLOR	OG	
1 SET QUANTITY		
REMARK	DEPLOYMENT BAG	

25. WEBBING,TEXTILE COTTON WARP

CODE NO	LBP-25	SAMPLE
PART NO	MIL-W-5665-3-1 1/4"	
WIDTHS	1 1/4"	
WEIGHTS	0.90 oz/liner yd(max)	
BREAKING STRENGTH	750 lbs	
MATERIAL	COTTON	
COLOR	OG	
1 SET QUANTITY		
REMARK	DEPLOYMENT BAG	

26. WEBBING, TEXTILE, NYLON, LOCKING LOOP

CODE NO	LBP-26	SAMPLE
PART NO	MIL-W-9406	
WIDTHS	90mm	
WEIGHTS	254-279.1 g/m(max)	
BREAKING STRENGTH	1100 lbs	
MATERIAL	COTTON	
COLOR		
1 SET QUANTITY		
REMARK	DEPLOYMENT BAG	



27. CLOTH, NETTING, PARACHUTE SKIRT EXTENSION, NYLON, RASCHEL KNIT

CODE NO	LBP-27	SAMPLE
PART NO	MIL-W-43805	
MESH SIZE	95.25 * 95.25	
WIDTHS	457.2±25.4	
BREAKING STRENGTH		
MATERIAL	NYLON	
COLOR	NW	
1 SET QUANTITY		
REMARK	MC1-1C	

28. COTTON ELASTIC WEBBING

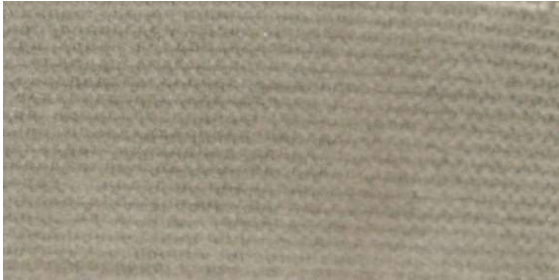
CODE NO	LBP-28	SAMPLE
PART NO	MIL-W-5664 1" OG	
WIDTHS	1"	
WEIGHTS	-	
BREAKING STRENGTH	-	
MATERIAL	ELASTIC	
COLOR		
1 SET QUANTITY		
REMARK	HARNESS & PACK TRAY	

29. TAPE, TEXTILE, NYLON, MULTIPLE TUBULAR

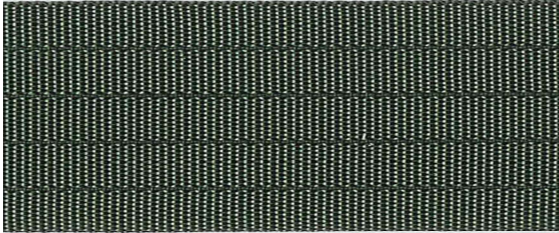
CODE NO	LBP-29	SAMPLE
PART NO	MIL-T-5666-1.5" OG	
WIDTHS	1 5/16"	
WEIGHTS	0.40 oz/liner yd(max)	
BREAKING STRENGTH	500 lbs	
MATERIAL	NYLON	
COLOR	OG	
1 SET QUANTITY		
REMARK	RESERVE PACK TRAY	

30. CORD, FIBROUS, NYLON

CODE NO	LBP-30	SAMPLE
PART NO	MIL-C-5040-T/2	
WIDTHS		
WEIGHTS	315 FEET/LBS(MIN)	
BREAKING STRENGTH	400 lbs	
MATERIAL	NYLON	
COLOR	OG	
1 SET QUANTITY		
REMARK	SUSPENSION LINE MC1-1C	



31. CORD, FIBROUS, NYLON

CODE NO	LBP-31	SAMPLE
PART NO	MIL-C-5040-T/3	
MESH SIZE		
WIDTHS	225 FEET/LBS(MIN)	
BREAKING STRENGTH	550 lbs	
MATERIAL	NYLON	
COLOR	OG	
1 SET QUANTITY		
REMARK	SUSPENSION LINE T-10R & MC1-1C	

32. CORD, FIBROUS, NYLON

CODE NO	LBP-32	SAMPLE
PART NO	MIL-C-5040-T/1A	
WIDTHS		
WEIGHTS	1050 FEET/LBS(MIN)	
BREAKING STRENGTH	100 lbs	
MATERIAL	NYLON	
COLOR	OG	
1 SET QUANTITY		
REMARK	SUSPENSION LINE PILOTCHUTE	

33. VELCRO TAPE

CODE NO	LBP-33	SAMPLE
PART NO		
WIDTHS		
WEIGHTS		
BREAKING STRENGTH		
MATERIAL		
COLOR	G	
1 SET QUANTITY		
REMARK	CARRYING BAG & PACK TRAY	

34. ZIPPER & SLIDER

CODE NO	LBP-34	SAMPLE
PART NO		
WIDTHS		
WEIGHTS		
BREAKING STRENGTH		
MATERIAL		
COLOR		
1 SET QUANTITY		
REMARK	CARRYING BAG	



35. Link Parachute Removable Connector

CODE NO	LBP-35	SAMPLE
PART NO	PS22002-1	
*Hot Forged Alloy Steel *100% Proof Load Tested @ 3000 lbs. *Approximate weight 2.6 ounces *Meets or exceeds PIA-H-7195		
1 SET QUANTITY	4 PCS	
REMARK	MC1-1C CANOPY	

36. Sap Assembly , Parachute Static Line

CODE NO	LBP-36	SAMPLE
PART NO	PS70120	
*Sheet Steel *100% Proof Load Tested @ 1750 lbs. *Approximate weight 8.5 ounces *Meets or exceeds PIA-H-7195		
1 SET QUANTITY	1 PCS	
REMARK	MC1-1C DEPLOYMENT BAG	

37. V-RING,Parachute Harness Triangle

CODE NO	LBP-37	SAMPLE
PART NO	PS22020-1	
*Hot Forged Alloy Steel *100% Proof Load Tested @ 2500 lbs. *Approximate weight 1.5 ounces *Meets or exceeds PIA-H-7195		
1 SET QUANTITY	2 PCS	
REMARK	MC1-1C HARNESS	

38. ADAPTER,QUICK FIT RESERSIBLE WITH TENSIONER & SPRING

CODE NO	LBP-38	SAMPLE
PART NO	PS70124-1	
*Hot Forged Alloy Steel *100% Proof Load Tested 2500 lbs. *Minimum Tensile Strength 4000 lbs. *Approximate weight 4.0 ounces *Meets or exceeds PIA-H-7195		
1 SET QUANTITY	2 PCS	
REMARK	MC1-1C HARNESS	



39. HOOK,SNAP,PARACHUTE HARNESS QUICK FIT,EJECTOR

CODE NO	LBP-B39	SAMPLE
PART NO	PS22017-1	
*Hot Forged Alloy Steel *Thermal Treated *100% Proof Load Tested @ 2500 lbs. *Approximate weight 4.0 ounces *Meets or exceeds PIA-H-7195		
1 SET QUANTITY	3 PCS	
REMARK	MC1-1C HARNESS	

40. V-Ring Adjustable,with Tensioner and Spring

CODE NO	LBP-40	SAMPLE
PART NO	PS27765-1	
*Hot Forged Alloy Steel *100% Proof Load Tested @ 2500 lbs. *Minimum Tensile Strength 5000 lbs. *Approximate weight 4.8 ounces *Meets or exceeds PIA-H-7195		
1 SET QUANTITY	3 PCS	
REMARK	MC1-1C HARNESS	

41. Adapter, Strap Adjusting

CODE NO	LBP-41	SAMPLE
PART NO	PS22014-3	
*Hot Forged Alloy Steel *100% Proof Load Tested 1000 lbs. *100% Side Load Tested 1000 lbs. *Minimum Tensile Strength 4000 LBS *Approximate weight 1.7 ounces		
1 SET QUANTITY	1 PCS	
REMARK	MC1-1C MAIN PACK	

42.D-Ring, Parachute Harness

CODE NO	LBP-42	SAMPLE
PART NO	11-1-485	
*Hot Forged Carbon Steel *Thermal Treated *100% Proof Load Tested @ 6000 lbs. *Approximate weight 4 ounces *Meets or exceeds PIA-H-7195		
1 SET QUANTITY	2 PCS	
REMARK	MC1-1C HARNESS	



43. FRAME PILOT CHUTE

CODE NO	LBP-43	SAMPLE
PART NO	59C22010	
*Approximate weight 4 ounces *STEEL SPRING WIRE		
1 SET QUANTITY	1 PCS	
REMARK	T-10R RESERVE PILOT CHUTE	

44. FRAME, CHEST PACK

CODE NO	LBP-44	SAMPLE
PART NO	42D14626	
*Approximate weight 5.4 ounces *STEEL SPRING WIRE		
1 SET QUANTITY	1 PCS	
REMARK	T-10R CHEST PACK	

45. RIPCORDER, PARACHUTE PERSONNEL

CODE NO	LBP-45	SAMPLE
PART NO	62C4250	
* GRIP : MS70106 STAINLESS STEEL 304-304 * STAINLESS STEEL AIRCRAFT WIRE 3/32" MIL-W-5424		
1 SET QUANTITY	1 PCS	
REMARK	T-10R CHEST PACK	

46. SPRING-RIPCORDER GRIP POCKET, PARACHUTE

CODE NO	LBP-46	SAMPLE
PART NO	48A6975	
*QQ-W-423 *COIL(24.5) PER INCH		
1 SET QUANTITY	1 PCS	
REMARK	T-10R CHEST PACK	



47. HOOK,SNAP,PARACHUTE CHEST TYPE CONNECTOR

CODE NO	LBP-47	SAMPLE
PART NO	PS70121-1	
*Hot Forged Alloy Steel *Thermal Treated *100% Proof Load Tested @ 5000 lbs. *Approximate weight 7.4 ounces *Meets or exceeds PIA-H-7195		
1 SET QUANTITY	2 PCS	
REMARK	T-10R CANOPY	

48. SPRING,BAND,PARACHUTE CONTAINER OPENING

CODE NO	LBP-48	SAMPLE
PART NO	46A3154-,3	
*QQ-W-423 *COIL(66) PER INCH		
1 SET QUANTITY	5 PCS / 10 PCS	
REMARK	T-10R CHEST PACK	

49. HOOK,BAND,PARACHUTE CONTAINER OPENING

CODE NO	LBP-49	SAMPLE
PART NO	46A3155	
*QQ-W-423 *Proof Load Tested 25 lbs.		
1 SET QUANTITY	6 PCS	
REMARK	T-10R CHEST PACK	

50. CONE,RELEASING, PARACHUTE PACK

CODE NO	LBP-50	SAMPLE
PART NO	PS27763	
*PS27763-1:BRASS QQ-B-626 COMP360 1/2 HARD CHROMIUM PLATING *PS27763-2:STEEL BAR QQ-S-764 303SE		
1 SET QUANTITY	2 PCS	
REMARK	T-10R CHEST PACK	



51. EYE-PARACHUTE PACK

CODE NO	LBP-51	SAMPLE
PART NO	50A6153	
*QQ-W-423		
1 SET QUANTITY	6 PCS	
REMARK	T-10R CHEST PACK	

52. GROMMET/WASHER PARACHUTE PACK

CODE NO	LBP-52	SAMPLE
PART NO	MS22048-C1	
*QQ-B-626		
*CHROMIUM PLATE		
1 SET QUANTITY	2 PCS	
REMARK	T-10R CHEST PACK	

53. SAFETY LOCKING PIN

CODE NO	LBP-53	SAMPLE
PART NO	55B6261	
1 SET QUANTITY	3 PCS	
REMARK	MC1-1C D-BAG & T-10R CHEST PACK	

54. STIFFENER

CODE NO	LBP-54	SAMPLE
PART NO	45A28142	
*PHENOLIC TYPE-FBM		
*MIL-P-15035		
1 SET QUANTITY	1 PCS	
REMARK	T-10R CHEST PACK	



55. REEFING RING

CODE NO	LBP-55	SAMPLE 
PART NO	PS27762-1	
*Carbon Steel *Approximate weight 1.0 ounces *Meets or exceeds PIA-H-7195		
1 SET QUANTITY	4 PCC	
REMARK	MC1-1C CANOPY & RISER	

56. TOGGLE

CODE NO	LBP-56	SAMPLE 
PART NO	68B219	
1 SET QUANTITY	2 PCS	
REMARK	MC1-1C CANOPY	

57. CANOPY RELEASE (MALE & FEMALE)

CODE NO	LBP-57	SAMPLE 
PART NO	100681 & 60J4328	
* HOT FORGE ALLOY STEEL * 100% PROOF LOAD TESTED : 5000 LBS (MALE & FEMALE) * 100% MALE & FEMALE FITTING TEST : 5000 LBS * 100681-2 : Approximate weight 8.0 ounces * 60J4328 : Approximate weight 4.0 ounces		
1 SET QUANTITY	2 SET	
REMARK	MC1-1C HARNESS	

58. RUBBER BAND

CODE NO	LBP-58	SAMPLE 
PART NO	MIL-R-1832	
1 SET QUANTITY	20. PCS	
REMARK	MC1-1C & T-10R PACKING	



59. SNAP FASTENER

CODE NO	LBP-59	SAMPLE 
PART NO	MS27983	
1 SET QUANTITY	5 SET	
REMARK	MC1-1C MAIN PACK	

60. NYLON THREAD

CODE NO	LBP-60	SAMPLE 
PART NO	V-T-295 SIZE "E" NW	
*MATERIAL : NYLON 66 *YARD/LBS : 5000(4572M) MIN *TENSILE STRENGTH (MIN) : 8.5LB MC1-		
1 SET QUANTITY		
REMARK	1C & T-10R SEWING THREAD	

61. NYLON YHREAD

CODE NO	LBP-61	SAMPLE 
PART NO	V-T-295 SIZE "E" OG	
*MATERIAL : NYLON 66 *YARD/LBS : 5000(4572M) MIN *TENSILE STRENGTH (MIN) : 8.5LB MC1-		
1 SET QUANTITY		
REMARK	1C & T-10R SEWING THREAD	

62. NYLON THREAD

CODE NO	LBP-62	SAMPLE 
PART NO	V-T-295 SIZE "FF" OG	
*MATERIAL : NYLON 66 *YARD/LBS : 3350(3063M) MIN *TENSILE STRENGTH (MIN) : 11LB MC1-		
1 SET QUANTITY		
REMARK	1C & T-10R SEWING THREAD	



63. NYLON THREAD

CODE NO	LBP-63	SAMPLE 
PART NO	V-T-295 SIZE "3" OG	
*MATERIAL : NYLON 66 *YARD/LBS : 1600(1463M) MIN *TENSILE STRENGTH (MIN) : 24LB		
1 SET QUANTITY		
REMARK	C & T-10R SEWING THREAD	

64. NYLON THREAD

CODE NO	LBP-64	SAMPLE 
PART NO	V-T-295 SIZE "4" OG	
*MATERIAL : NYLON 66 *YARD/LBS : 1200(1097M) MIN *TENSILE STRENGTH (MIN) : 32LB		
1 SET QUANTITY		
REMARK	C & T-10R SEWING THREAD	

65. NYLON THREAD

CODE NO	LBP-65	SAMPLE 
PART NO	V-T-295 SIZE "5" OG	
*MATERIAL : NYLON 66 *YARD/LBS : 950(868M) MIN *TENSILE STRENGTH (MIN) : 40LB		
1 SET QUANTITY		
REMARK	C & T-10R SEWING THREAD	

66. NYLON THREAD

CODE NO	LBP-66	SAMPLE 
PART NO	V-T-295 SIZE "6" OG	
*MATERIAL : NYLON 66 *YARD/LBS : 775(708M) MIN *TENSILE STRENGTH (MIN) : 50LB		
1 SET QUANTITY		
REMARK	MC1-1C & T-10R SEWING THREAD	